

Power Semiconductors
Discretes and Stacks
2019

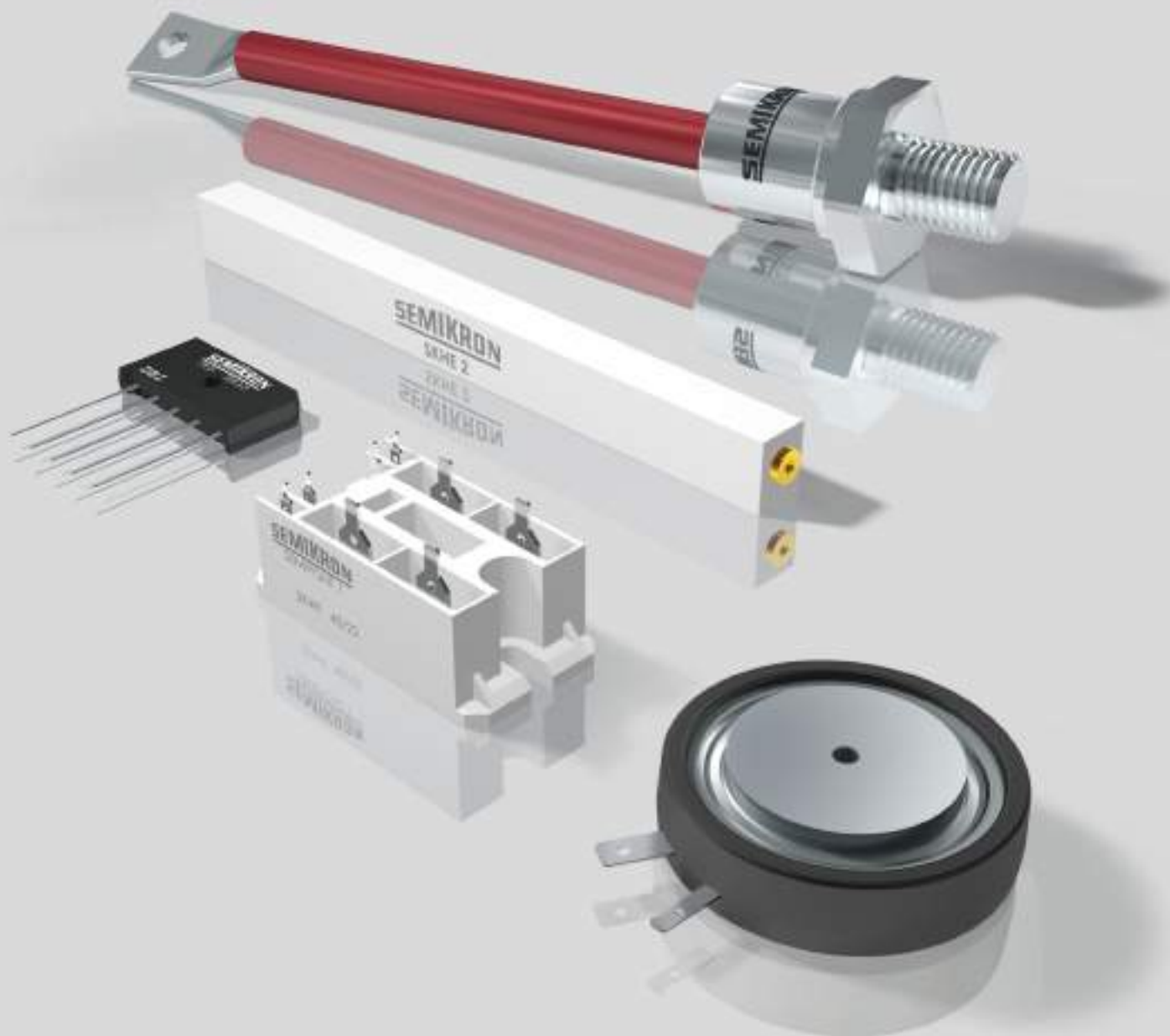



Power Semiconductors
Discretes and Stacks
2019

Contents

Table for calculating rectifier circuits		05	Single phase bridge rectifiers	BI 6, BI 6 P, BI 25, BI 25 P SKB 25 ... SKB 72	24
Thermal Calculation Method		06	Controlled single phase bridge rectifiers	Controlled bridges Thyristor modules	26
Mount procedures for stud screw fit devices		07	Three-phase bridge rectifiers	DBI 6 ... SKD 31 SKD 25 ... SKD 82	27
Thyristors - SCR	Stud thyristors	09	Heatsinks		29
	Capsule thyristors	13	Clamps		34
Leaded diodes	Fast recovery	15	Power electronic Stacks		35
	Standard recovery	15	Letter symbols		37
	Avalanche type	16			
Stud diodes	Standard recovery	17			
	Fast recovery	20			
	Avalanche type	21			
Capsule diodes	SKN 503 SG ... SKN 6000	22			
High voltage rectifier diodes	SKHE 2000, SKHE 3500	23			

Table for Calculating Rectifier Circuits¹⁾

Connection code (IEC)		E1	M2	B2	M3	B6	M6	(M3)2
Circuit								
Name of the connection								
Pulse number per cycle	<i>n</i>	1	2	2	3	6	6	6
Conduction period	α	180°el	180°el	180°el	120°el	120°el	60°el	120°el
No-load output voltage	$V_{o,av}$	0,45 x V_i	0,45 x V_i	0,9 x V_i	0,67 x V_i	1,35 x V_i	0,67 x V_i	0,67 x V_i
Form factor	$f_f = \frac{V_{o,rms}}{V_{o,av}}$	1,57	1,11	1,11	1,017	1,001	1,001	1,001
Ripple content	$W = 100 \cdot \sqrt{f_f^2 - 1}$	121%	48%	48%	18,3%	4,2%	4,2%	4,2%
Diode average current	$I_{d,av}$	1,0 x I_o	0,5 x I_o	0,5 x I_o	0,33 x I_o	0,33 x I_o	0,1666 x I_o	0,1666 x I_o
Diode RMS current	$I_{d,rms}$	1,57 x I_o	0,79 x I_o	0,79 x I_o	0,59 x I_o	0,59 x I_o	0,41 x I_o	0,29 x I_o
RMS current in the secondary		1,57 x I_o	0,79 x I_o	1,11 x I_o	0,59 x I_o	0,82 x I_o	0,41 x I_o	0,29 x I_o
Transformer secondary power		3,50 x (V_o x I_o)	1,75 x (V_o x I_o)	1,23 x (V_o x I_o)	1,48 x (V_o x I_o)	1,05 x (V_o x I_o)	1,81 x (V_o x I_o)	1,48 x (V_o x I_o)
Transformer primary power		2,68 x (V_o x I_o)	1,23 x (V_o x I_o)	1,23 x (V_o x I_o)	1,22 x (V_o x I_o)	1,05 x (V_o x I_o)	1,29 x (V_o x I_o)	1,05 x (V_o x I_o)
Semiconductor peak reverse voltage		3,14 x	3,14 x	1,57 $V_{o,av}$	2,09 x	1,05 $V_{o,av}$	2,09 $V_{o,av}$	2,42 $V_{o,av}$

¹⁾ All values applied to resistive load. Losses in the rectifier assembly and transformer are neglected

For more detailed information, contact SEMIKRON.

Thermal Calculation Method

For the thermal calculus with mains frequency, diodes and thyristors are electrically described as a continuous voltage source in series with a resistance.

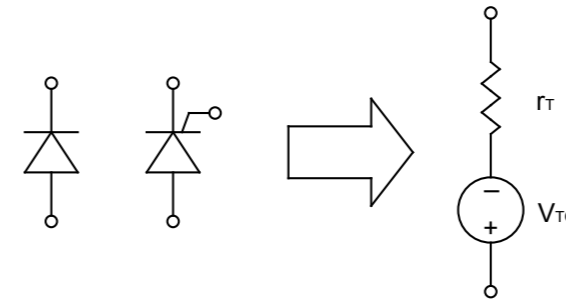

The dissipated power in each semiconductor can be obtained by the following equation:

$$P_D = I_{AV\ DIO/THY} \cdot V_{TO} + I_{RMS\ DIO/THY}^2 \cdot r_T$$

Where:

- $I_{AV\ DIO/THY}$ is the average current on the device
- $I_{RMS\ DIO/THY}$ is the RMS current on the device
- V_{TO} is the threshold voltage of the device
- r_T is the on-state slope resistance of the device

$I_{AV\ DIO/THY}$ and $I_{RMS\ DIO/THY}$ derived from the converter's output current and from the used topology - they can be estimated through the table in page 06 of this shortform. V_{TO} and r_T are given in the first page of each device's datasheet.

The following values are necessary for the thermal calculus:

- T_{amb} [°C]: Input temperature in the heatsink of the cooling air or of the liquid coolant.
- **n**: Number of modules or of discrete devices on the heatsink.
- **N**: Number of semiconductors on the heatsink. For discrete devices $n = N$, although $n = 1$ and $N = 4$ if a compact mono-phase bridge (which has 4 internal diodes) is assembled in a heatsink, for example.
- T_{vj} [°C]: Maximum junction temperature allowed in the device, value given in the datasheet.
- F_s : Safety factor for operation temperature, a safety factor should always be considered in order to not use the device in its maximum allowed temperature. The usual F_s is 0,85.
- R_{thjc} [K/W ou °C/W]: Thermal resistance junction to case (total), value given in the datasheet.
- R_{thcs} [K/W ou °C/W]: Thermal resistance case to heatsink (total), value given in the datasheet.

With all values available, substitute them in the following equation:

$$R_{thsa\ max} = \frac{F_s \cdot T_{vj} - T_{amb}}{P_D \cdot N} - \frac{(R_{thjc} + R_{thcs})}{n} \quad [K/W]$$

Notes on **n** and **N**: A single stud diode on a heatsink: $n = 1$ and $N = 1$. Two stud thyristors on a heatsink: $n = 2$ and $N = 2$. Three stud diodes on a heatsink: $n = 3$ and $N = 3$. A single three-phase bridge on a heatsink: $n = 1$ and $N = 6$. Two mono-phase bridges on a heatsink: $n = 2$ and $N = 4 \times 2 = 8$. The total dissipated power on the heatsink is equal to $P_D \times N$.

The equation's result will be the maximum allowed value for the thermal resistance from heatsink to air (or to the liquid coolant), that will maintain the junction temperature below $F_s \cdot T_{vj}$. A heatsink with suitable R_{thsa} should be chosen from the heatsink section of this shortform (pages 29 to 33). It is also important to check if the heatsink's dimensions (length and profile) are adequate for the chosen devices and application.

In case a compact rectifier bridge is used without heatsink, the term $(R_{thjc} + R_{thcs})$ should be replaced by the value of $R_{thja\ iso}$ (freely suspended in air) or $R_{thja\ chassis}$ (for direct use in the equipment's chassis). In this scenario the equation's result must be equal or greater than zero ($R_{thsa\ max} \geq 0$), this means that the chosen configuration is adequate to the specification.

For more detailed information, contact SEMIKRON.

Mounting Procedures for Stud Screw Fit Devices

Stud devices have various advantages in use when compared to other case types; they are hermetically sealed, versatile and robust. However, some guidelines must be followed in order to not damage them during assembling nor reduce their lifetime.

A. Terminal soldering guidelines for stud devices without stranded wire rope

- The component must be preferably mounted into the heatsink first, which will avoid internal overheat of the device. If a heatsink is not used the soldering time must be reduced to the minimum necessary;
- An thermostatically-controlled soldering iron must be used and its temperature must be between 250°C and 350°C in order to avoid both cold solder joint or damage to the isolation of the wire to be soldered;
- Pre-heat the eyelet using the soldering iron during 3-10 s, depending on device's size and iron temperature;
- Contact time between soldering iron and device eyelet must be limited to approx. 10-30 s during soldering, depending on iron temperature and component's size;
- Clean the eyelet after the soldering process with a brush soaked with Isopropyl Alcohol (wait until the component cool down);
- Forces applied to the eyelet may damage the semiconductor chip inside the component. The cable to be soldered cannot apply significant forces on the device's upper contact;
- The final solder must be homogeneous, with good wetting and forming a meniscus with concave surface;



Example:

The following parameters were used to solder a SKN26 diode (picture at left):

- Soldering Iron at 300°C;
- Eyelet pre-heating: 3 s;
- Contact time between the soldering iron and eyelet during soldering: 10 s.

B. Guidelines for cable connection by screw and nut



- Attach the cable to the component before mounting it in the heatsink - this will avoid damaging the device during mounting;
- The cable's eyelet must be compatible with the device's eyelet to assure good electrical connection;
- Nut and screw with dimensions compatible to the eyelet must be used together with adequate flat and lock washers;
- Use preferably one box-ended wrench and a torque wrench to apply torque to the screw;
- The applied torque to the screw must be within the permitted range, with the device free suspended during the operation to avoid forces over the isolation glass.

Mounting Procedures for Stud Screw Fit Devices

C. Guidelines for stud devices mounting in aluminum heatsinks or metal plates

In order to mount a stud device you will need:

- SEMIKRON stud diode or thyristor;
- Heatsink with threaded or through hole, or metallic plate with through hole;
- Thermal paste (recommended by SEMIKRON);
- Brush (to apply the thermal paste);
- Isopropyl alcohol;
- Cleaning rag;
- Torque wrench;
- Socket for the torque wrench with adequate dimensions for the stud device;

The heatsink or metal plate must be free of burrs and splinters and be properly machined with maximum rugosity and flatness of 10 µm. The hole must be perpendicular to the mounting surface.



1st Step: Clean up the heatsink or metal plate with isopropyl alcohol. The fixing hole should be cleaned as well to remove oil, greases and other chemical residues.



2nd Step: Apply a thin layer of thermal paste (60 µm maximum) with the brush. SEMIKRON indicates Wacker P12 thermal paste to mount stud type devices.



3rd Step: Insert and screw the device manually until its base reaches the heatsink. If a nut is being used to tight the component, maintain the nut still and turn the device manually until it reaches the heatsink.



4th Step: Apply the datasheet recommended torque in the device with a properly adjusted torque wrench. It is very important stop torqueing when the signal that adjusted torque was reached is emitted. The click-type will emit a click sound and the break-over type will deflect its handle. Tightening must be stopped, to avoid excessive torque over the device.

After mounting, the device can be tested with a multimeter or a curve tracer to confirm that it was not damaged during assembling.

Stud Screw Fit Thyristors

TYPES	V_{RRM}	I_{TRMS}	I_{TAV}	I_{TSM}	I^2T	$(\frac{dv}{dt})_{CR}$	V_T	T_{vj}	$V_{T(TO)}$	r_T	V_{GT}	I_{GT}	R_{thjc}	R_{thjc}	R_{thch}
	V_{DRM}		180° el (T_{case} °C)	$T_{vj} = 25^\circ C$ 10ms	A^2s	V/ μs	V	°C	V	m Ω	V	mA	sin. 180° el	rec. 120° el	°C/W
SKT 10/06 D	600					500									
SKT 10/08 D	800	30	10	250	310	500	1,6	130	1,0	18	3	100	1,3	1,35	1
SKT 10/12 E	1200		(111)			1000	(30A)								
SKT 16/04 D	400					500									
SKT 16/06 D	600					500									
SKT 16/08 D	800					500									
SKT 16/12 E	1200	40	16	370	680	1000	2,4	130	1,0	20	3	100	0,9	0,95	0,5
SKT 16/14 E	1400		(104)			1000	(75A)								
SKT 16/16 E	1600					1000									
SKT 16/18 E	1800					1000									
SKT 24/04 D	400					500									
SKT 24/08 D	800					500									
SKT 24/12 E	1200	50	24	450	1000	1000	1,9	130	1,0	10	3	100	0,9	0,95	0,5
SKT 24/14 E	1400		(95)			1000	(75A)								
SKT 24/16 E	1600					1000									
SKT 24/18 E	1800					1000									
SKT 40/04 D	400					500									
SKT 40/06 D	600					500									
SKT 40/08 D	800					500									
SKT 40/12 E	1200	63	40	700	2500	1000	1,95	130	1,0	9	3	150	0,66	0,70	0,2
SKT 40/14 E	1400		(80)			1000	(120A)								
SKT 40/16 E	1600					1000									
SKT 40/18 E	1800					1000									
SKT 50/06 D	600					500									
SKT 50/08 D	800					500									
SKT 50/12 E	1200	78	50	1050	5000	1000	1,8	130	1,1	5	3	150	0,6	0,65	0,2
SKT 50/14 E	1400		(78)			1000	(120A)								
SKT 50/16 E	1600					1000									
SKT 50/18 E	1800					1000									
SKT 55/04 D	400					500									
SKT 55/06 D	600					500									
SKT 55/08 D	800					500									
SKT 55/12 E	1200	110	55	1300	8500	1000	1,8	130	0,9	4	3	150	0,47	0,53	0,08
SKT 55/14 E	1400		(92)			1000	(200A)								
SKT 55/16 E	1600					1000									
SKT 55/18 E	1800					1000									
SKT 80/06 D	600					500									
SKT 80/08 D	800					500									
SKT 80/12 E	1200	135	80	1700	14500	1000	2,25	130	1,2	4	3	150	0,28	0,31	0,08
SKT 80/14 E	1400		(85)			1000	(300A)								
SKT 80/16 E	1600					1000									
SKT 80/18 E	1800					1000									

Heat Sink	T_{amb} max	$I_D @ 0,85 \cdot T_{vj}$			OUTLINES
		I_D	$V_{T(TO)}$	r_T	
KP 2/120N	45	19	27	22	B1: SKT 10 SW11, M5 Peso: 7g
KP 1,4/120N	45	22	30	24	
KP 2/120N	45	22	31	25	B2: SKT 16, SKT 24 SW14, M6 Peso: 13g
KP 1,4/120N	45	26	35	29	
KP 1,25/120N	45	27	37	29	
KP 2/120N	45	26	37	29	B3: SKT 40, SKT 50 SW17, M8 Peso: 22g
KP 1,4/120N	45	31	42	34	
KP 1,25/120N	45	32	44	36	
KP 2/120N	45	32	44	34	B5: SKT 55, SKT 80 SW24, M12 Peso: 100g
KP 1,4/120N	45	38	52	41	
KP 1,25/120N	45	39	53	43	
KP 1,25/120N	45	57	77	61	
KP 0,8/120N	45	72	97	80	
KP 0,6/120N	45	77	107	86	
KP 1,25/120N	45	51	70	57	
KP 0,8/120N	45	72	93	76	
KP 0,6/120N	45	77	104	85	

Stud Screw Fit Thyristors

TYPES	V_{RRM}	I_{TRMS}	I_{TAV}	I_{TSM}	I^2T	$(\frac{dv}{dt})_{CR}$	V_T	T_{vj}	$V_{T(TO)}$	r_T	V_{GT}	I_{GT}	R_{thjc}	R_{thjc}	R_{thch}
	V_{DRM}		180° el (T_{case} °C)	$T_{vj} = 25^\circ C$ 10ms	A^2s	V/ μs	V	°C	V	m Ω	V	mA	sin. 180° el	rec. 120° el	°C/W
SKT 100/04 D	400					500									
SKT 100/08 D	800					500									
SKT 100/12 E	1200	175	100	2000	20000	1000	1,75	130	1,0	2,4	3	150	0,28	0,31	0,08
SKT 100/14 E	1400		(85)			1000	(300A)								
SKT 100/16 E	1600					1000									
SKT 100/18 E	1800					1000									
SKT 130/04 D	400					500									
SKT 130/06 D	600					500									
SKT 130/08 D	800	220	130	3500	61000	500	2,25	130	1,2	2,2	3	200	0,18	0,2	0,03
SKT 130/12 E	1200		(85)			1000	(500A)								
SKT 130/14 E	1400					1000									
SKT 130/16 E	1600					1000									
SKT 160/04 D	400					500									
SKT 160/06 D	600					500									
SKT 160/08 D	800	280	160	4300	92500	500	1,75	130	1,0	1,5	3	200	0,18	0,2	0,03
SKT 160/12 E	1200		(84)			1000	(500A)								
SKT 160/14 E	1400					1000									
SKT 160/16 E	1600					1000									
SKT 250/04 D	400					500									
SKT 250/08 D	800					500									
SKT 250/12 E	1200	450	250	7000	245000	1000	1,65	130	1,0	0,7	3	200	0,123	0,137	0,015
SKT 250/14 E	1400		(85)			1000	(800A)								
SKT 250/16 E	1600					1000									
SKT 300/04 D	400					500									
SKT 300/08 D	800					500									
SKT 300/12 E	1200	550	300	11000	600000	1000	1,45	130	0,9	0,5	3	200	0,096	0,101	0,015
SKT 300/14 E	1400		(93)			1000	(800A)								
SKT 300/16 E	1600					1000									
SKT 354/12 E	1200	550	350	11000	600000	1000	1,45	130	0,9	0,5	3	200	0,096	0,101	0,015
SKT 354/15 E	1500		(85)			1000	(800A)								

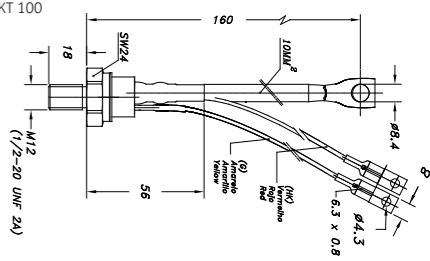
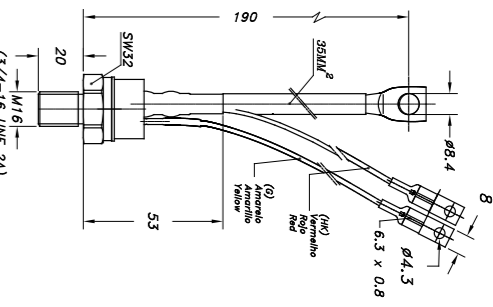
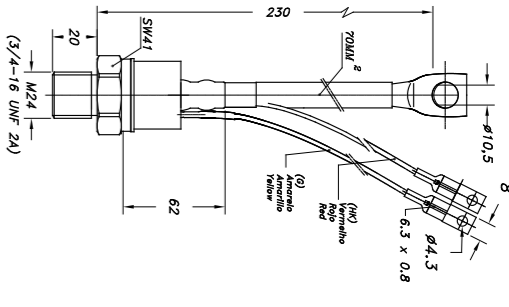
Heat Sink	T_{amb} max °C	$I_D @ 0,85 \cdot T_{vj}$				OUTLINES
		63	87	115	129	
						
SKT 100/04 D	45	63	87	70	 <p>B5: SKT 55, SKT 80, SKT 100 SW24, M12 Peso: 100g</p>	
SKT 100/08 D	45	89	115	93		
SKT 100/12 E	45	95	129	105		
SKT 130/04 D	45	96	132	107		
SKT 130/06 D	45	109	149	121		
SKT 130/08 D	45	134	182	149		
SKT 160/04 D	45	116	158	129	 <p>B6: SKT 130, SKT 160 SW32, M16 Peso: 250g</p>	
SKT 160/06 D	45	131	179	146		
SKT 160/08 D	45	161	219	179		
SKT 250/04 D	45	147	188	163		
SKT 250/06 D	45	166	228	175		
SKT 250/08 D	45	224	288	235		
SKT 300/04 D	45	171	232	190	 <p>B7: SKT 250, SKT 300 SW41, M24 Peso: 490g</p>	
SKT 300/06 D	45	194	268	204		
SKT 300/08 D	45	266	345	296		
SKT 354/12 E	45	132	179	146		
SKT 354/15 E	45	156	212	173		
P 3/200N	45	203	281	214		

Capsule Thyristors

TYPES	V_{RRM}	I_{TRMS}	I_{TAV}	I_{TSM}	I^2T	$(\frac{dv}{dt})_{CR}$	V_T	T_{vj}	$V_{T(TO)}$	r_T	V_{GT}	I_{GT}	R_{thjc}	R_{thjc}	R_{thch}
	V_{DRM}	A	180° el ($T_{case} \text{ } ^\circ\text{C}$)	A	$T_{vj} = 25^\circ\text{C}$ 10ms A^2s	$\text{V}/\mu\text{s}$	V	$^\circ\text{C}$	V	$\text{m}\Omega$	V	mA	sin. 180° el DSC $^\circ\text{C}/\text{W}$	rec. 120° el DSC $^\circ\text{C}/\text{W}$	DSC $^\circ\text{C}/\text{W}$
SKT 340/12 E	1200					1000									
SKT 340/16 E	1600	700	340	5700	162000	1000	1,9	125	1,0	0,9	2	150	0,072	0,08	0,02
SKT 340/18 E	1800		(82)			1000	(1000)								
SKT 551/12 E	1200					1000									
SKT 551/16 E	1600	1200	550	9000	405000	1000	1,65	125	0,925	0,45	3	250	0,047	0,054	0,012
SKT 551/18 E	1800		(85)			1000	(1500A)								
SKT 553/04 SG	400					500									
SKT 553/08 SG	800					500									
SKT 553/12 SG	1200	1200	554	9000	405000	1000	1,65	125	0,92	0,45	3	250	0,047	0,052	0,011
SKT 553/16 SG	1600		(84)			1000	(1500A)								
SKT 553/18 SG	1800					1000									
SKT 760/12 E	1200					1000									
SKT 760/16 E	1600	1600	760	15000	1125000	1000	1,65	125	0,92	0,3	3	200	0,04	0,045	0,007
SKT 760/18 E	1800		(80)			1000	(2400A)								
SKT 813/04 D	600					500									
SKT 813/08 D	800					500									
SKT 813/12 E	1200	1600	810	15000	1125000	1000	1,65	125	0,92	0,3	3	200	0,03	0,032	0,0065
SKT 813/16 E	1600		(88)			1000	(2400A)								
SKT 813/18 E	1800					1000									
SKT 883/04 D	400					500									
SKT 883/08 D	800					500									
SKT 883/12 E	1200	1900	890	19000	1620000	1000	1,46	125	0,85	0,25	3	240	0,032	0,035	0,005
SKT 883/16 E	1600		(85)			1000	(2400A)								
SKT 883/18 E	1800					1000									
SKT 1200/12 E	1200					1000									
SKT 1200/16 E	1600	2800	1200	30000	4500000	1000	1,65	125	0,95	0,18	3	250	0,0225	0,027	0,005
SKT 1200/18 E	1800		(85)			1000	(3600A)								

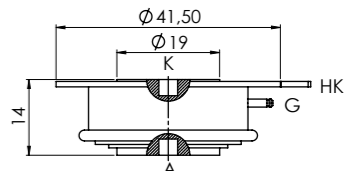
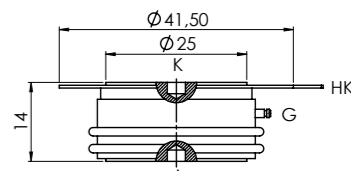
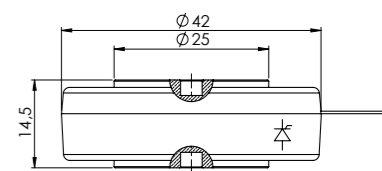
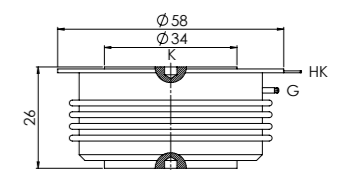
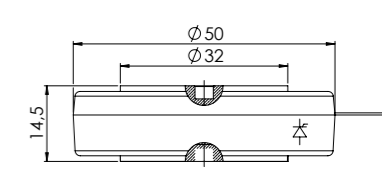
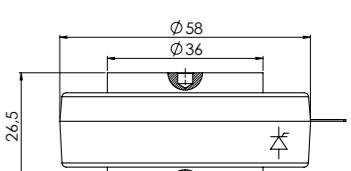
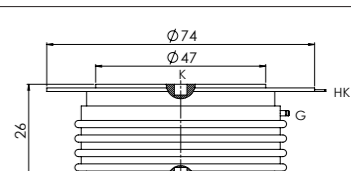
Heat Sink	T_{amb} max $^\circ\text{C}$	$I_D @ 0,85 \cdot T_{vj}$			OUTLINES
		$I_{D\text{rec}} \text{ (A)}$	$I_{D\text{max}} \text{ (A)}$	$I_{RMS\text{max}} \text{ (A)}$	
02 X P9/200N	45	248	338	275	B8: SKT 340 14 x 19 x 41,5mm Peso: 61g 
02 x P9/300N	45	283	400	315	
02 X P0,45/250N	45	296	403	329	
02 X P9/200N	45	314	430	349	B11: SKT 551 14,5 x 25 x 41,5mm Peso: 105g 
02 x P9/300N	45	385	523	408	
02 X P0,45/250N	45	387	527	430	
02 X P9/200N	45	316	434	351	B11b: SKT 553 SG 14,5 x 25 x 42mm Peso: 85g 
02 x P9/300N	45	388	529	411	
02 X P0,45/250N	45	390	533	433	
02 X P9/200N	45	342	471	380	B10: SKT 760 26 x 34 x 58mm Peso: 240g 
02 x P9/300F	35	1096	1507	1218	
02 X P0,45/250F	35	1114	1530	1237	
02 X P9/200N	45	351	486	390	B21: SKT 813 14,5 x 32 x 50mm Peso: 150g 
02 x P9/300F	35	1195	1673	1328	
02 X P0,45/250F	35	1216	1701	1351	
02 X P9/200N	45	381	526	423	B23: SKT 883 26,5 x 36 x 58mm Peso: 280g 
02 x P9/300F	35	1295	1800	1439	
02 X P0,45/250F	35	1318	1830	1465	
02 X P9/200N	45	368	536	409	B14: SKT 1200 26 x 47 x 73,8 mm Peso: 480g 
02 x P9/300F	35	1431	1969	1590	
02 X P0,45/250F	35	1461	2007	1623	

Fast Leaded Diodes

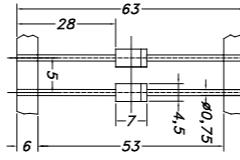
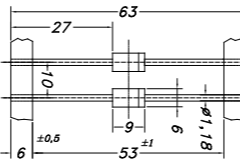
TYPES	V_{RRM}	I_{FRMS}	t_{rr}	I_{FAV}	I_{FSM}	I^2T	V_F	T_{vj}	R_{thja}	OUTLINES
	V	A	μs	180° el A	$T_{vj} = 25^\circ C$ 10ms A	A ² s	$T_{vj} = 25^\circ C$ max (I _F) V	T_{vj} max °C	°C/W	
SK 1M16	1600	3	1,3	1,1	60	18	1,5	130	85	E33: 4,5 x 7 x 63mm Peso: 0,6g 
SK 3M16	1600	6,3	1,3	3,4	140	98	1,45	150	60	E34: 6 x 9 x 63mm Peso: 1g 

Standard Recovery Leaded Diodes

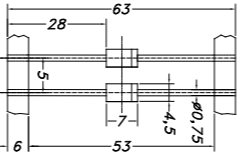
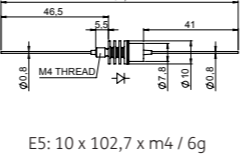
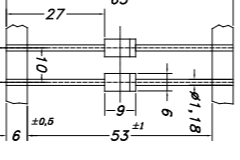
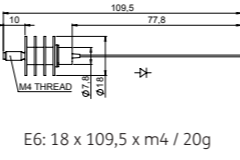
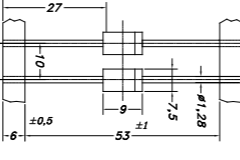
TYPES	V_{RRM}	I_{FRMS}	I_{FAV}	I_{FSM}	I^2T	V_F	T_{vj}	R_{thja}	$I_D @ 0,85 \cdot T_{vj}$		OUTLINES
	V	A	180° el A	$T_{vj} = 25^\circ C$ 10ms A	A ² s	$T_{vj} = 25^\circ C$ max (I _F) V	T_{vj} max °C	°C/W	$I_{D,rec}$ (A)	$I_{D,rec}$ (A)	
SK 1/10	1000										
SK 1/12	1200	3	1,2	60	18	1,5	150	85	2	2,9	
SK 1/14	1400		$T_{ref} = 100^\circ C$						$T_{ref} = 85^\circ C$	$T_{ref} = 85^\circ C$	
SK 1/16	1600										
SKN 2,5/04	400										
SKN 2,5/08	800	5	2,5	180	160	1,2	180	55	3,9	5,7	
SKN 2,5/12	1200		$T_o = 45^\circ C$						$T_o = 45^\circ C$	$T_o = 45^\circ C$	
SKN 2,5/16	1600										
SK 3/10	1000										
SK 3/12	1200	6,7	3	180	162	1,2	150	60	4,6	6,7	
SK 3/14	1400		$T_{ref} = 90^\circ C$						$T_{ref} = 85^\circ C$	$T_{ref} = 85^\circ C$	
SK 3/16	1600										
SKN 5/02	200										
SKN 5/04	400		5						7,6	11,3	
SKN 5/08	800	10	$T_o = 45^\circ C$	190	180	1,25	180	25	$T_o = 45^\circ C$	$T_o = 45^\circ C$	
SKN 5/12	1200										
SKN 5/16	1600										
SK 6/04	400										
SK 6/08	800		6						5,4	7,9	
SK 6/10	1000	10	$T_{ref} = 50^\circ C$	375	700	1,1	150	55	$T_{ref} = 85^\circ C$	$T_{ref} = 85^\circ C$	
SK 6/12	1200										
SK 6/16	1600										

Avalanche Leaded Diodes

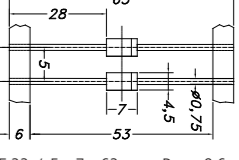
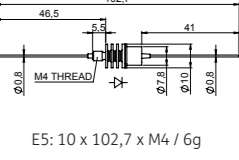
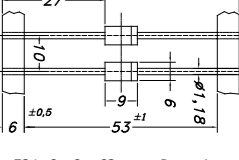
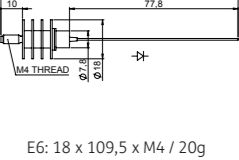
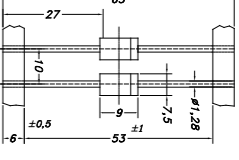
TYPES	V_{BR}	I_{FRMS}	I_{FAV}	I_{FSM}	I^2T	V_F	T_{vj}	R_{thja}	$I_D @ 0,85 \cdot T_{vj}$		OUTLINES
	V	A	180° el A	$T_{vj} = 25^\circ C$ 10ms A	A ² s	$T_{vj} = 25^\circ C$ max (I _F) V	T_{vj} max °C	°C/W	$I_{D,rec}$ (A)	$I_{D,rec}$ (A)	
SKa 1/13	1300	3	1	60	18	1,5	150	85	2	2,9	
SKa 1/17	1700								$T_{amb} = 60^\circ C$	$T_{ref} = 85^\circ C$ $T_{ref} = 85^\circ C$	
SKNa 2/13	1300	5	2	180	160	1,2	150	55	1,6	2,3	
SKNa 2/17	1700								$T_{amb} = 45^\circ C$	$T_{amb} = 45^\circ C$	
SKa 3/13	1300										
SKa 3/17	1700	6,7	3	180	160	1,2	150	60	4,3	6,3	
SKa 3/20	2000								$T_{ref} = 90^\circ C$	$T_{ref} = 85^\circ C$ $T_{ref} = 85^\circ C$	
SKNa 4/13	1300	10	4	190	180	1,2	150	25	3,1	4,6	
SKNa 4/17	1700								$T_{amb} = 35^\circ C$	$T_{amb} = 45^\circ C$ $T_{amb} = 45^\circ C$	
SKa 6/13	1300										
SKa 6/17	1700	10	6	375	700	1,1	150	55	4,8	7,1	
SKa 6/20	2000								$T_{ref} = 50^\circ C$	$T_{ref} = 85^\circ C$ $T_{ref} = 85^\circ C$	

Stud Screw Fit Rectifier Diodes

TYPES		V_{RRM}	I_{FRMS}	I_{FAV} 180°el $T_{case} = 125^{\circ}C$ $f = 60Hz$	I_{FSM}	I^2t $T_{vj} = 25^{\circ}C$ 10ms	V_F max (I _F) $T_{vj} = 25^{\circ}$	T_{vj} max	R_{thjc} 180°el	R_{thch} 180°el	M_s	$I_D @ 0,85 * T_{vj}$ 	Heat Sink $V_{air} = 6m/s$	OUTLINES
		V	A	A	A	kJA²s	V	°C	°C/W	°C/W	Nm	$I_{D,rec}(A)$ 		
SKN 20/04	SKR 20/04	400												
SKN 20/08	SKR 20/08	800										32	45	KP 2/120N
SKN 20/12	SKR 20/12	1200	40	20	375	0,7	1,55	180	2	1	2	35	48	KP 1,4/120N
SKN 20/14	SKR 20/14	1400					(60A)					36	50	KP 1,25/120N
SKN 20/16	SKR 20/16	1600												$T_{amb} = 45^{\circ}C$
SKN 26/04	SKR 26/04	400												
SKN 26/08	SKR 26/08	800										32	45	KP 2/120N
SKN 26/12	SKR 26/12	1200	40	20	375	0,7	1,55	180	2	1	2	35	48	KP 1,4/120N
SKN 26/14	SKR 26/14	1400					(60A)					36	50	KP1,25/120N
SKN 26/16	SKR 26/16	1600												$T_{amb} = 45^{\circ}C$
SKN 45/04	SKR 45/04	400												
SKN 45/08	SKR 45/08	800										71	94	KP 1,25/120N
SKN 45/12	SKR 45/12	1200	80	45	700	2,5	1,6	180	0,85	0,25	4	83	112	KP 0,8/120N
SKN 45/14	SKR 45/14	1400					(150A)					86	119	KP 0,6/120N
SKN 45/16	SKR 45/16	1600												$T_{amb} = 45^{\circ}C$
SKN 70/04	SKR 70/04	400												
SKN 70/08	SKR 70/08	800										91	120	KP 1,25/120N
SKN 70/12	SKR 70/12	1200	150	72	1150	6,6	1,5	180	0,55	0,2	4	110	151	KP 0,8/120N
SKN 70/14	SKR 70/14	1400					(200A)					119	160	KP 0,6/120N
SKN 70/16	SKR 70/16	1600												$T_{amb} = 45^{\circ}C$
SKN 71/02	SKR 71/02	200												
SKN 71/04	SKR 71/04	400										91	120	KP 1,25/120N
SKN 71/08	SKR 71/08	800	150	72	1150	6,6	1,5	180	0,55	0,2	4	110	151	KP 0,8/120N
SKN 71/12	SKR 71/12	1200					(200A)					119	160	KP 0,6/120N
SKN 71/14	SKR 71/14	1400												$T_{amb} = 45^{\circ}C$
SKN 71/16	SKR 71/16	1600												
SKN 94/02	SKR 94/02	200												
SKN 94/04	SKR 94/04	400										119	163	KP 1,25/120N
SKN 94/08	SKR 94/08	800	150	126	2000	20	1,2	180	0,35	0,2	4	150	207	KP 0,8/120N
SKN 94/12	SKR 94/12	1200					(300A)					165	228	KP 0,6/120N
														$T_{amb} = 45^{\circ}C$



Stud Screw Fit Rectifier Diodes

TYPES		V_{RRM}	I_{FRMS}	I_{FAV} 180°el $T_{case} = 125^{\circ}C$ $f = 60Hz$	I_{FSM}	I^2t $T_{vj} = 25^{\circ}C$ 10ms	V_F max (I _F) $T_{vj} = 25^{\circ}$	T_{vj} max	R_{thjc} 180°el	R_{thch} 180°el	M_s	$I_D @ 0,85 * T_{vj}$ 	Heat Sink $V_{air} = 6m/s$	OUTLINES
		V	A	A	A	kJA²s	V	°C	°C/W	°C/W	Nm	$I_{D,rec}(A)$ 		
SKN 96/02	SKR 96/02	200										119	163	KP 1,25/120N
SKN 96/04	SKR 96/04	400	150	126	2000	20	1,2	180	0,35	0,2	4	150	207	KP 0,8/120N
SKN 96/08	SKR 96/08	800					(300A)					165	228	KP 0,6/120N
SKN 96/12	SKR 96/12	1200												$T_{amb} = 45^{\circ}C$
SKN 100/04	SKR 100/04	400												
SKN 100/08	SKR 100/08	800										139	200	KP 0,8/120N
SKN 100/12	SKR 100/12	1200	200	95	1750	15	1,55	180	0,45	0,08	10	153	219	KP 0,6/120N
SKN 100/14	SKR 100/14	1400					(400A)					170	243	KP 0,4/120N
SKN 100/16	SKR 100/16	1600												$T_{amb} = 45^{\circ}C$
SKN 100/18	SKR 100/18	1800												
SKN 130/04	SKR 130/04	400												
SKN 130/08	SKR 130/08	800										158	228	KP 0,8/120N
SKN 130/12	SKR 130/12	1200	260	130	2500	31	1,5	180	0,35	0,08	10	176	253	KP 0,6/120N
SKN 130/14	SKR 130/14	1400					(500A)					198	284	KP 0,4/120N
SKN 130/16	SKR 130/16	1600												$T_{amb} = 45^{\circ}C$
SKN 130/18	SKR 130/18	1800												
SKN 152/02	SKR 152/02	200										186	268	KP 0,8/120N
SKN 152/04	SKR 152/04	400	300	190	4500	101	1,4	180	0,22	0,08	8	209	300	KP 0,6/120N
SKN 152/08	SKR 152/08	800					(500A)					239	342	KP 0,4/120N
SKN 152/12	SKR 152/12	1200												$T_{amb} = 45^{\circ}C$
SKN 240/04	SKR 240/04	400												
SKN 240/08	SKR 240/08	800										208	304	KP 0,8/120N
SKN 240/12	SKR 240/12	1200	500	240	6000	180	1,4	180	0,2	0,03	30	239	347	KP 0,6/120N
SKN 240/14	SKR 240/14	1400					(750A)					279	405	KP 0,4/120N
SKN 240/16	SKR 240/16	1600												$T_{amb} = 45^{\circ}C$
SKN 240/18	SKR 240/18	1800												
SKN 262/20	SKR 262/20	2000										239	347	KP 0,6/120N
SKN 262/24	SKR 262/24	2400	500	240	6000	180	1,4	180	0,2	0,03	30	279	405	KP 0,4/120N
SKN 262/28	SKR 262/28	2800					(750A)					338	487	KP 0,4/120N
														$T_{amb} = 45^{\circ}C$

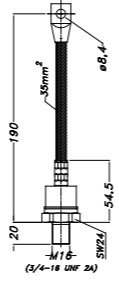
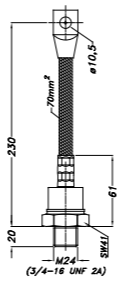
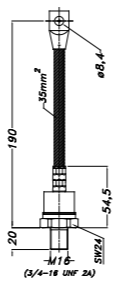
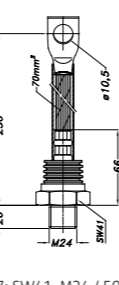
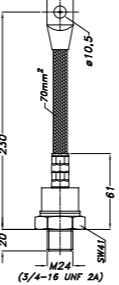
Stud Screw Fit Rectifier Diodes

TYPES	V_{RRM}	I_{FRMS}	I_{FAV} 180°el $T_{case} = 125^{\circ}C$ $f = 60Hz$	I_{FSM}	I^2T	V_F max (I_F) $T_{vj} = 25^{\circ}C$	T_{vj} max	R_{thjc} 180°el	R_{thch} 180°el	M_s	$I_D @ 0,85 * T_{vj}$		Heat Sink $V_{dir} = 6m/s$	OUTLINES
											I_{D1}	I_{D2}		
	V	A	A	A	KA^2s	V	$^{\circ}C$	$^{\circ}C/W$	$^{\circ}C/W$	Nm				
SKN 300/04 SKR 300/04	400										261	379	KP 0,6/120N	 <p>E15: SW32, M16 / 250g</p>
SKN 300/08 SKR 300/08	800	500	296	6500	211	1,4	180	0,15	0,03	30	308	420	KP 0,4/120N	
SKN 300/12 SKR 300/12	1200												KP 0,4/200N	
SKN 300/16 SKR 300/16	1600												KP 0,4/200N $T_{amb} = 45^{\circ}C$	
SKN 320/04 SKR 320/04	400												KP 0,6/120N	 <p>E16: SW41, M24 / 500g</p>
SKN 320/08 SKR 320/08	800										274	400	KP 0,4/120N	
SKN 320/12 SKR 320/12	1200	700	320	9000	405	1,35	180	0,16	0,015	60	326	445	KP 0,4/200N	
SKN 320/14 SKR 320/14	1400										402	580	KP 0,4/200N $T_{amb} = 45^{\circ}C$	
SKN 320/16 SKR 320/16	1600												KP 0,4/200N $T_{amb} = 45^{\circ}C$	
SKN 390/04 SKR 390/04	400										279	406	KP 0,6/120N	 <p>E15: SW32, M16 / 250g</p>
SKN 390/08 SKR 390/08	800	620	355	9000	405	1,35	180	0,13	0,03	30	332	453	KP 0,4/120N	
SKN 390/12 SKR 390/12	1200										411	593	KP 0,4/200N	
SKN 390/16 SKR 390/16	1600												KP 0,4/200N $T_{amb} = 45^{\circ}C$	
SKN 400/18 SKR 400/18	1800												KP 0,6/120N	 <p>E17: SW41, M24 / 500g</p>
SKN 400/20 SKR 400/20	2000										227	332	KP 0,6/120N	
SKN 400/24 SKR 400/24	2400	700	260	9000	405	1,45	160	0,11	0,01	60	274	368	KP 0,4/120N	
SKN 400/27 SKR 400/27	2700										347	503	KP 0,4/200N	
SKN 400/30 SKR 400/30	3000												KP 0,4/200N $T_{amb} = 45^{\circ}C$	
SKN 400/36 SKR 400/36	3600												KP 0,4/200N $T_{amb} = 45^{\circ}C$	
SKN 600/04 SKR 600/04	400										308	452	KP 0,6/120N	 <p>E16: SW41, M24 / 500g</p>
SKN 600/08 SKR 600/08	800	950	475	14000	980	1,33	180	0,1	0,015	60	374	510	KP 0,4/120N	
SKN 600/12 SKR 600/12	1200										475	690	KP 0,4/200N	
SKN 600/16 SKR 600/16	1600												KP 0,4/200N $T_{amb} = 45^{\circ}C$	

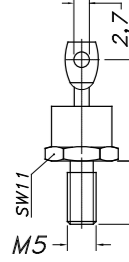
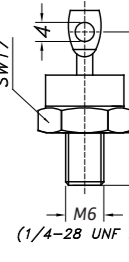
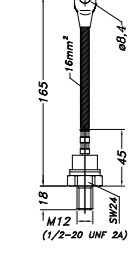
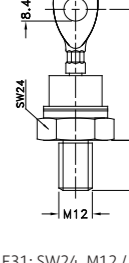
Stud Screw Fit Fast Diodes

TYPES	V_{RRM}	I_{FRMS}	Q_{rr}	t_{rr}	I_{FAV} 180°el $T_{case} = 100^{\circ}C$ $f = 60Hz$	I_{FSM}	I^2t	V_F max (I_F) $T_{vj} = 25^{\circ}C$	T_{vj} max	R_{thjc} 180°el	R_{thch} 180°el	M_s	OUTLINES
SKN 2F17/04 SKR 2F17/04	400												 <p>E7: SW11, M5 / 7g</p>
SKN 2F17/06 SKR 2F17/06	600	41	1	0,44	22	450	1000	2,15	150	1,2	0,5	1,5	
SKN 2F17/08 SKR 2F17/08	800											(50A)	
SKN 2F17/10 SKR 2F17/10	1000												
SKN 3F20/08 SKR 3F20/08	800												 <p>E7: SW11, M5 / 7g</p>
SKN 3F20/10 SKR 3F20/10	1000	41	1,5	0,6	22	375	700	2,15	150	1,2	0,5	1,5	
SKN 3F20/12 SKR 3F20/12	1200											(50A)	
SKN 2F50/04 SKR 2F50/04	400												 <p>E10: SW17, M6 / 20g</p>
SKN 2F50/06 SKR 2F50/06	600	100	3	0,6	57	1100	6000	1,8	150	0,5	0,25	2,5	
SKN 2F50/08 SKR 2F50/08	800											(50A)	
SKN 2F50/10 SKR 2F50/10	1000												
SKN 60F12 SKR 60F12	1200												 <p>E10: SW17, M6 / 20g</p>
SKN 60F14 SKR 60F14	1400	120	75	2,1	60	1400	9800	1,75	150	0,5	0,25	2,5	
SKN 60F15 SKR 60F15	1500											(150A)	
SKN 60F17 SKR 60F17	1700												
SKN 135F08 SKR 135F08	800												 <p>E14: SW24, M12 / 100g</p>
SKN 135F10 SKR 135F10	1000	260	50	1,9	135	2500	31000	1,95	150	0,2	0,08	10	
SKN 135F12 SKR 135F12	1200											(300A)	
SKN 140F12 SKR 140F12	1200												 <p>E31: SW24, M12 / 75g</p>
SKN 140F14 SKR 140F14	1400	260	90	2,0	140	2500	31000	1,8	150	0,2	0,08	10	
SKN 140F15 SKR 140F15	1500											(300A)	
SKN 140F17 SKR 140F17	1700												
SKN 136F08 SKR 136F08	800												<p>E31: SW24, M12 / 75g</p>
SKN 136F10 SKR 136F10	1000	260	50	1,9	135	2500	31000	1,95	150	0,2	0,08	10	
SKN 136F12 SKR 136F12	1200											(300A)	
SKN 141F12 SKR 141F12	1200												<p>E31: SW24, M12 / 75g</p>
SKN 141F14 SKR 141F14	1400	260	90	2,0	140	2500	31000	1,8	150	0,2	0,08	10	
SKN 141F15 SKR 141F15	1500											(300A)	
SKN 141F17 SKR 141F17	1700												

Stud Screw Fit Avalanche Diodes

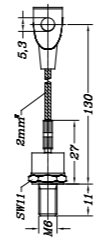
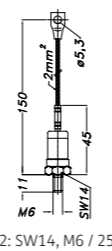
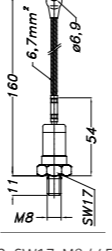
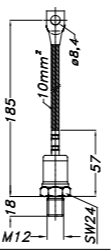
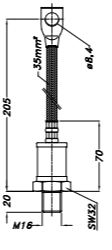
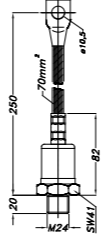
TYPES	V _(BR)	I _{FRMS}	I _{FAV} 180°el T _{case} = 125°C f = 60Hz	I _{FSM}	I ² t T _{vj} = 25°C 10ms	V _F max (I _F) T _{vj} = 25°C	T _{vj} max	R _{thjc} 180°el	R _{thch} 180°el	Ms	I _{DC} @ 0,85 * T _{vj}		Heat Sink V _{air} = 6m/s	OUTLINES
											I _{DC} (A)	I _{DC} (A)		
SKNa 20/13	1300										29	41	KP 1,25/120N T _{amb} = 45°C	 <p>E9: SW11, M6 / 11g</p>
SKNa 20/17	1700	40	10	375	0,7	1,55	150	2	1	2	33	46	KP 0,8/120N T _{amb} = 45°C	
SKNa 22/36	3600													 <p>E42: SW14, M6 / 25g</p>
SKNa 22/40	4000													
SKNa 22/42	4200	40	18	450	1,0	1,95	160	1	1	2	30	41	KP 1,25/120N	
SKNa 22/46	4600					(60A)					33	46	KP 0,8/120N	
SKNa 22/48	4800										34	48	KP 0,6/120N T _{amb} = 45°C	
SKNa 22/50	5000													
SKNa 47/36	3600													 <p>E43: SW17, M8 / 45g</p>
SKNa 47/40	4000													
SKNa 47/42	4200													
SKNa 47/45	4500	80	33	700	2,5	1,8	160	0,6	0,25	4	54	71	KP 1,25/120N	
SKNa 47/46	4600					(100A)					64	85	KP 0,8/120N	
SKNa 47/48	4800										66	91	KP 0,6/120N T _{amb} = 45°C	
SKNa 47/50	5000													
SKNa 102/36	3600													 <p>E44: SW24, M12 / 110g</p>
SKNa 102/40	4000													
SKNa 102/42	4200													
SKNa 102/45	4500	200	70	1900	18	1,9	160	0,3	0,08	10	104	141	KP 1,25/120N	
SKNa 102/46	4600					(300A)					115	161	KP 0,8/120N	
SKNa 102/48	4800										124	171	KP 0,6/120N T _{amb} = 45°C	
SKNa 102/50	5000													
SKNa 202/36	3600													 <p>E45: SW32, M16 / 260g</p>
SKNa 202/40	4000													
SKNa 202/42	4200													
SKNa 202/45	4500	500	112	3800	72	1,95	160	0,2	0,03	30	133	191	KP 1,25/120N	
SKNa 202/46	4600					(600A)					150	204	KP 0,8/120N	
SKNa 202/48	4800										174	228	KP 0,6/120N T _{amb} = 45°C	
SKNa 202/50	5000													
SKNa 402/36	3600													 <p>E46: SW41, M24 / 550g</p>
SKNa 402/40	4000													
SKNa 402/42	4200													
SKNa 402/45	4500	700	238	7800	300	1,85	160	0,1	0,01	60	199	290	KP 0,6/120N	
SKNa 402/46	4600					(1,2kA)					241	311	KP 0,4/120N	
SKNa 402/48	4800										304	438	KP 0,4/200N T _{amb} = 45°C	
SKNa 402/50	5000													

Capsule Rectifier Diodes

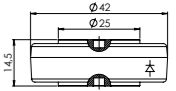
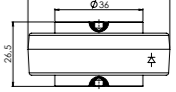
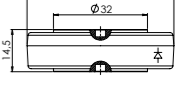
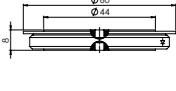
TYPES	V _{RRM}	I _{FAV} DSC 180°el T _{case} = 125° f = 60Hz	I _{FSM}	I ² t T _{vj} = 25°C 10ms	V _F max (I _F) T _{vj} = 25°C	T _{vj} max	R _{thjc} 180°el DSC	R _{thch} DSC	F	I _D @ 0,85 * T _{vj}		Heat Sink V _{air} = 6m/s	OUTLINES
										I _D (A)	I _D (A)		
SKN 503/04 SG	400												 <p>E25: 14,5 x 25 x 42 mm</p>
SKN 503/08 SG	800									535	694	P9/200N	
SKN 503/12 SG	1200	483	7	245	1,5	180	75	12	4...5	603	815	P9/300N	
SKN 503/18 SG	1800				(1500A)					627	818	P0,45/250N	
SKN 503/22 SG	2200											T _{amb} = 45°C	
SKN 1503/04 SG	400									737	945	P9/200N	 <p>E26: 26,5 x 36 x 58 mm</p>
SKN 1503/08 SG	800											T _{amb} = 45°C	
SKN 1503/12 SG	1200	1144	19	1800	1,5	175	33	5	12...13,5	1909	2685	P9/300F	
SKN 1503/18 SG	1800				(3000A)							T _{amb} = 35°C	
SKN 1503/22 SG	2200									1939	2727	P0,45/250F T _{amb} = 35°C	
SKN 1603/04	400									740	948	P9/200N	 <p>E27: 14,5 x 32 x 50 mm</p>
SKN 1603/08	800											T _{amb} = 45°C	
SKN 1603/12	1200	1155	19	1800	1,5	175	30	6,5	12...13,5	1931	2716	P9/300F	
SKN 1603/18	1800				(3000A)							T _{amb} = 35°C	
SKN 1603/22	2200									1963	2759	P0,45/250F T _{amb} = 35°C	
SKN 6000/02	200									1074	1461	P9/200N	 <p>E35: 8 x 44 x 60 mm</p>
SKN 6000/04	400	4135	60	18000	1,3	180	12	5	24...30	3890	5617	T _{amb} = 45°C	
SKN 6000/06	600				(14kA)					3987	5753	P9/300F T _{amb} = 35°C P0,45/250F T _{amb} = 35°C	

High Voltage Rectifier Diodes

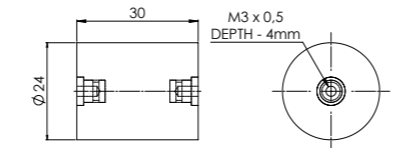
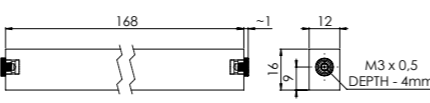
TYPES	V _(BR) V	V _{RRM} V	I _{FAV} 180° el T _{amb} = 45°C A	I _{FAV} 180° el T _{oil} = 75°C A	I _{FSM} A	I ² t T _{vj} max 10ms A ² s	V _F max (I _F) T _{vj} = 25°C V	T _{vj} max °C	OUTLINES
SKHE2000/900-1,2	6.000	4.800	1,25	1,5	135	91	3,6 (1,5A)	150	
SKHE3500/1500-2	10.000	8.000	2,1	2,5	270	364	6,7 (1A)	150	

Both diodes have avalanche characteristic, what means that they can be used in series to withstand even higher voltages

Single Phase Bridge Rectifiers

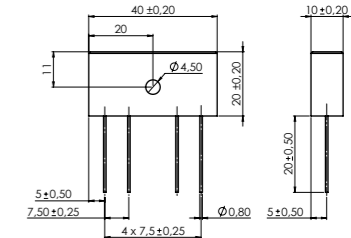
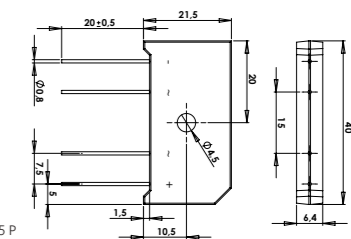
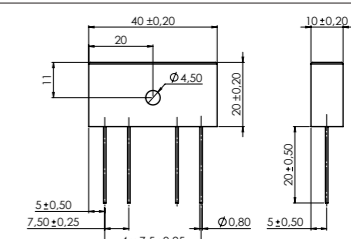
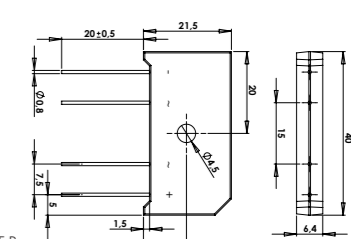
TYPES	V _{RRM} V	V _{RMS} indicado V	I _D max (T _{case} °C) A	I _{FSM} T _{vj} = 25°C 10ms A	I ² t A ² s	T _{vj} max °C	R _{thja} chassis °C/W	OUTLINES
BI 6/04	400	125						 <p>BI: BI 6, BI 25 Peso: 20g</p>
BI 6/08	800	250	9	200	200	150	7	
BI 6/12	1200	380	(65)					
BI 6/16	1600	500						
BI 6/18	1800	560						
BI 6-04 P	400	125						 <p>BI P: BI 6 P, BI 25 P Peso: 12g</p>
BI 6-08 P	800	250	10	200	200	150	5,2	
BI 6-12 P	1200	380	(102)					
BI 6-16 P	1600	500						
BI 6-18 P	1800	560						
BI 6-20 P*	2000	625						
BI 6-22 P*	2200	680						
BI 25/04	400	125						 <p>BI: BI 6, BI 25 Peso: 20g</p>
BI 25/08	800	250	25	370	680	150	5	
BI 25/12	1200	380	(26)					
BI 25/16	1600	500						
BI 25/18	1800	560						
BI 25-04 P	400	125						 <p>BI P: BI 6 P, BI 25 P Peso: 12g</p>
BI 25-08 P	800	250	25	370	680	150	5	
BI 25-12 P	1200	380	(26)					
BI 25-16 P	1600	500						
BI 25-18 P	1800	560						
BI 25-20 P*	2000	625						
BI 25-22 P*	2200	680						

* Available in limited quantities

Single Phase Bridge Rectifiers

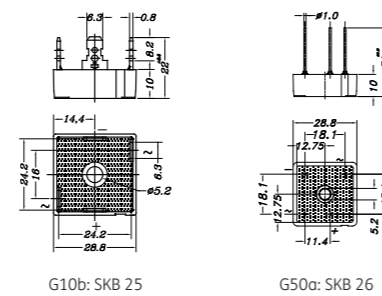
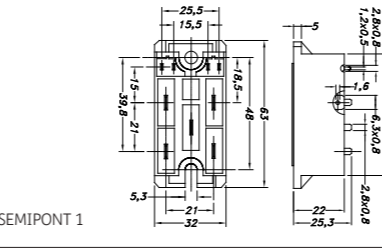
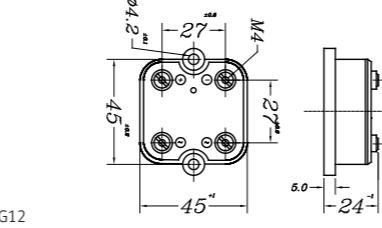
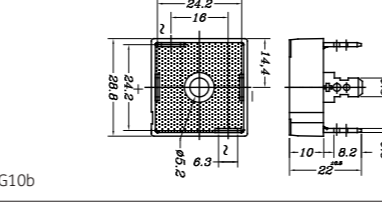
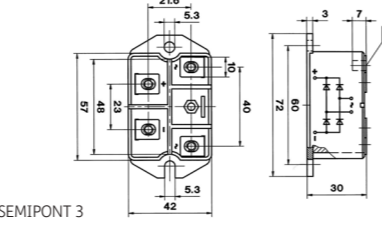
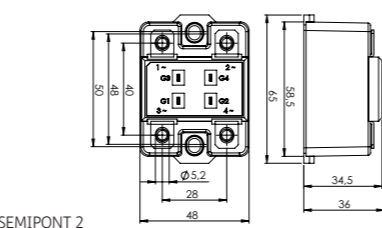
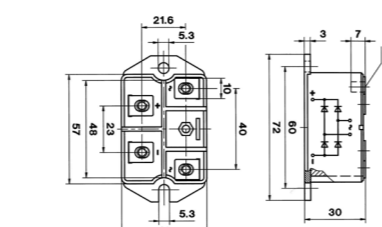
TYPES	V_{RRM}	V_{RMS}	$I_{d\ max}$	I_{FSM}	I^2t	$T_{vj\ max}$	R_{thjc}	OUTLINES
	V	V	A	A	A ² s	°C	°C/W	
SKB 25/02	200	60						 <p>G10b: SKB 25 G50a: SKB 26</p>
SKB 25/04	400	125						
SKB 25/06	600	200	17	370	680	150	2	
SKB 25/08	800	250	(75)					
SKB 25/12	1200	380						
SKB 25/14	1400	440						
SKB 25/16	1600	500						
SKB 28/02	200	60						 <p>SEMIPONT 1</p>
SKB 28/04	400	125						
SKB 28/08	800	250	30	370	680	125	0,5	
SKB 28/12	1200	380	(85)					
SKB 28/14	1400	440						
SKB 28/16	1600	500						
SKB 30/02 A1	200	60						 <p>G12</p>
SKB 30/04 A1	400	125						
SKB 30/08 A1	800	250	30	370	680	150	0,7	
SKB 30/12 A1	1200	380	(94)					
SKB 30/14 A1	1400	440						
SKB 30/16 A1	1600	500						
SKB 35/04	400	125						 <p>G10b</p>
SKB 35/08	800	250	35	380	700	150	1,5	
SKB 35/12	1200	380	(29)					
SKB 35/16	1600	500						
SKB 52/04	400	125						 <p>SEMIPONT 3</p>
SKB 52/08	800	250						
SKB 52/12	1200	380	50	500	1250	150	0,375	
SKB 52/14	1400	440	(99)					
SKB 52/16	1600	500						
SKB 52/18	1800	560						
SKB 60/04	400	125						 <p>SEMIPONT 2</p>
SKB 60/08	800	250						
SKB 60/12	1200	380	60	1000	5000	125	0,25	
SKB 60/14	1400	440	(88)					
SKB 60/16	1600	500						
SKB 72/04	400	125						 <p>SEMIPONT 3</p>
SKB 72/08	800	250						
SKB 72/12	1200	380	70	750	2800	150	0,275	
SKB 72/14	1400	440	(101)					
SKB 72/16	1600	500						
SKB 72/18	1800	560						

Controlled Single Phase Bridges

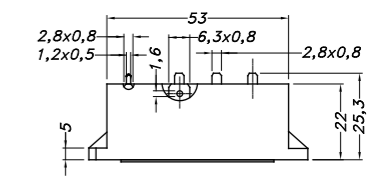
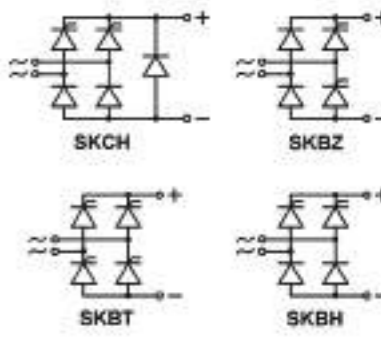
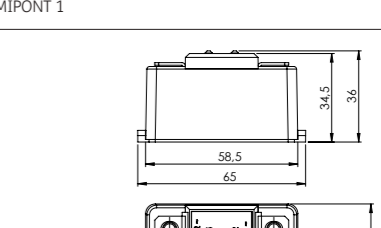
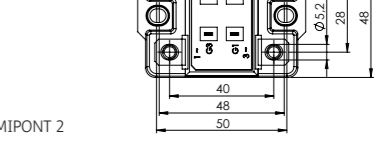
TYPES	V_{RRM}	$I_{o\ max}$	I_{TSM}	I^2t	V_{GT}	I_{GT}	$T_{vj\ max}$	R_{thjc}	OUTLINES
	V	A	A	A ² s	V	mA	°C	°C/W	
SKBH 28/04	400								
SKBH 28/08	800								
SKBH 28/12	1200	28	320	510	2	100	125	0,45	
SKBH 28/14	1400	(89)							
SKBH 28/16	1600								
SKBZ 28/04	400								
SKBZ 28/06	600								
SKBZ 28/08	800	28	320	510	2	100	125	0,45	
SKBZ 28/12	1200	(89)							
SKBZ 28/14	1400								
SKCH 28/04	400								
SKCH 28/06	600								
SKCH 28/08	800	28	320	510	2	100	125	0,45	
SKCH 28/12	1200	(89)							
SKCH 28/14	1400								
SKCH 28/16	1600								
SKBT 28/06	600								 <p>SEMIPONT 1</p>
SKBT 28/08	800	28	320	510	2	100	125	0,45	
SKBT 28/12	1200	(89)							
SKBT 28/14	1400								
SKCH 40/04	400								
SKCH 40/08	800								
SKCH 40/12	1200	40	470	1100	3	150	125	0,25	
SKCH 40/14	1400	(92)							
SKCH 40/16	1600								
SKBT 40/08	800								
SKBT 40/12	1200	40	470	1100	3	150	125	0,25	
SKBT 40/14	1400	(92)							
SKBT 40/16	1600								

Thyristor Modules

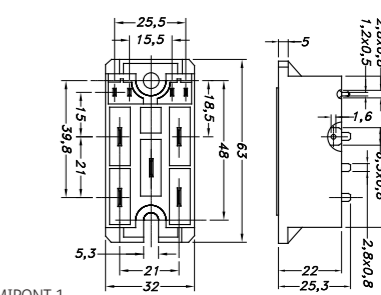
TYPES	V_{RRM}	$I_{rms\ max}$	I_{TSM}	I^2t	V_{GT}	I_{GT}	$T_{vj\ max}$	R_{thjc}	OUTLINES
	V	A	A	A ² s	V	mA	°C	°C/W	
SKWT 40/08	800								 <p>SEMIPONT 1</p>
SKWT 40/12	1200	40	700	2500	3	150	125	0,4	
SKWT 40/16	1600	(91)							
SKWT 40/22	2200								

Three-Phase Bridge Rectifiers

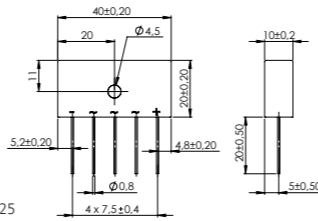
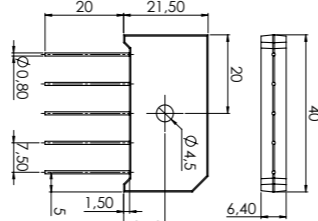
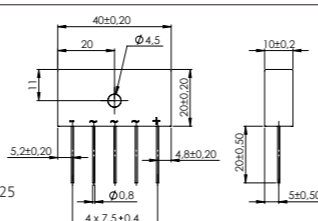
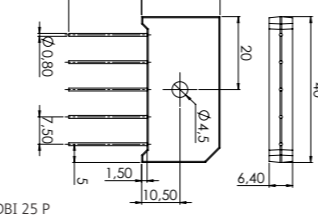
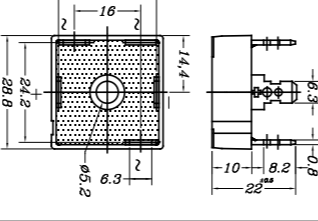
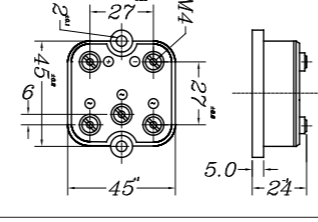
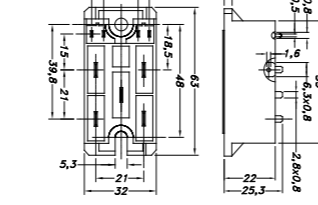
TYPES	V_{RRM}	V_{RMS}	$I_o \text{ max}$	I_{FSM}	I^2t	$T_{vj} \text{ max}$	$R_{thjc} \text{ (tot)}$	OUTLINES	
	V	V	($T_{case} \text{ } ^\circ\text{C}$) A	$T_{vj} = 25^\circ\text{C}$ 10ms A	A ² s	$^\circ\text{C}$	$^\circ\text{C/W}$		
DBI 6-04	400	125						 <p>DBI: DBI 6, DBI 25</p>	
DBI 6-08	800	250							
DBI 6-12	1200	380	9	180	162	150	3		
DBI 6-14	1400	440	(90)						
DBI 6-16	1600	500							
DBI 6-18	1800	560							
DBI 6-04 P	400	125						 <p>DBI P: DBI 6 P, DBI 25 P</p>	
DBI 6-08 P	800	250							
DBI 6-12 P	1200	380	9	200	200	150	2		
DBI 6-16 P	1600	500	(113)						
DBI 6-18 P	1800	560							
DBI 6-20 P*	2000	625							
DBI 6-22 P*	2200	680							
DBI 25-04	400	125						 <p>DBI: DBI 6, DBI 25</p>	
DBI 25-08	800	250							
DBI 25-12	1200	380	25	370	680	150	2,2		
DBI 25-16	1600	500	(32)						
DBI 25-18	1800	560							
DBI 25-04 P	400	125							 <p>DBI P: DBI 6 P, DBI 25 P</p>
DBI 25-08 P	800	250							
DBI 25-12 P	1200	380	27	370	680	150	1,7		
DBI 25-16 P	1600	500	(32)						
DBI 25-18 P*	1800	560							
DBI 25-22 P*	2200	680							
SKD 25/02	SKD 26/02	200	60					 <p>G11b</p>	
SKD 25/04	SKD 26/04	400	125						
SKD 25/08	SKD 26/08	800	250	20	370	680	150		1,75
SKD 25/12	SKD 26/12	1200	380	(73)					
SKD 25/14	SKD 26/14	1400	440						
SKD 25/16	SKD 26/16	1600	500						
SKD 30/02 A1		200	60					 <p>G13</p>	
SKD 30/04 A1		400	125						
SKD 30/08 A1		800	250	30	370	680	150		0,7
SKD 30/12 A1		1200	380	(98)					
SKD 30/14 A1		1400	440						
SKD 30/16 A1		1600	500						
SKD 31/02		200	60					 <p>SEMIPONT 1</p>	
SKD 31/04		400	125						
SKD 31/08		800	250	31	370	685	125		0,33
SKD 31/12		1200	380	(100)					
SKD 31/14		1400	440						
SKD 31/16		1600	500						

*Available in limited quantities

Three-Phase Bridge Rectifiers

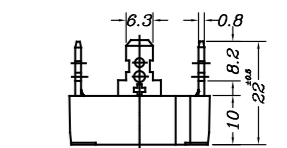
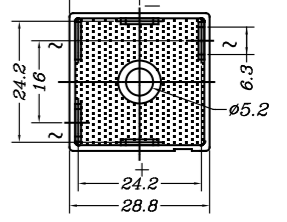
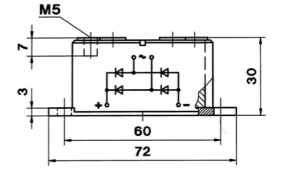
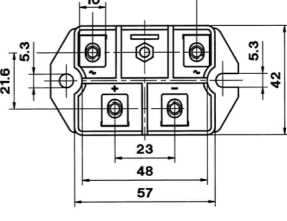
TYPES	V_{RRM}	V_{RMS}	$I_o \text{ max}$	I_{FSM}	I^2t	$T_{vj} \text{ max}$	$R_{thjc} \text{ (tot)}$	OUTLINES
	V	V	($T_{case} \text{ } ^\circ\text{C}$) A	$T_{vj} = 25^\circ\text{C}$ 10ms A	A ² s	$^\circ\text{C}$	$^\circ\text{C/W}$	
SKD 35/04	400	125						
SKD 35/08	800	250						
SKD 35/10	1000	310	36	370	680	150	1,0	
SKD 35/12	1200	380	(70)					
SKD 35/14	1400	440						
SKD 35/16	1600	500						
SKD 35/12 AV	1200	380	40	400	800	150	0,9	 <p>G11b</p>
SKD 35/16 AV	1600	500	(70)					
SKD 62/04	400	125						
SKD 62/08	800	250						
SKD 62/12	1200	380	60	500	1250	150	0,25	
SKD 62/14	1400	440	(110)					
SKD 62/16	1600	500						
SKD 62/18*	1800	560						
SKD 82/04	400	125						 <p>SEMIPONT 3</p>
SKD 82/08	800	250						
SKD 82/12	1200	380	80	750	2800	150	0,183	
SKD 82/14	1400	440	(110)					
SKD 82/16	1600	500						
SKD 82/18*	1800	560						

* Available in limited quantities

For more detailed information, contact SEMIKRON. V_{RRM} indicado pode variar de acordo com a aplicação.



Heatsinks

TYPES	WEIGHT kg/L=100mm	R_{thho}	R_{thho}	OUTLINES	THERMAL RESISTANCE
		NATURAL °C/W (L =100 mm)	FORCED °C/W (L =100 mm)		
KP 1,4	0,29	1,4 (40W)	-----		B1 ... B5, E5 ... E14, DO-8, E42 ... E44, G10b, G11b, G50a, G50b, BI, BI P, DBI, DBI P
KP 1,25	0,42	1,25 (50W)	-----		B1 ... B5, E5 ... E14, E31, DO-8, E42 ... E44, G10b, G11b, G50a, G50b, G12, G13, BI, BI P, DBI, DBI P, SEMIPONT 1 ... 3
KP 3	0,19	3,0 (20W)	-----		B1 ... B3, E6 ... E12, E42, E43
KP 2	0,32	2,0 (30W)	-----		B1 ... B5, E6 ... E14, E31, E42 ... E44
KP 0,8	0,87	0,8 (60W)	0,23		B1 ... B5, E7 ... E14, E31, DO-8, E42 ... E44, G10b, G11b, G50a, G50b, SEMIPONT 1

Heatsinks

TYPES	WEIGHT kg/L=100mm	R_{thho}	R_{thho}	OUTLINES	THERMAL RESISTANCE
		NATURAL °C/W (L =100 mm)	FORCED °C/W (L =100 mm)		
KP 0,6	1,17	0,65 (80W)	0,19		B3 ... B7, E10 ... E17, E31, DO-8, E42 ... E46, G10b, G11b, G50a, G50b, G12, G13, BI, BI P, DBI, DBI P, SEMIPONT
KP 0,4	2	0,4 (140W)	0,15		B3 ... B7, E10 ... E17, E31, DO-8, E42 ... E46, G10b, G11b, G50a, G50b, G12, G13, SEMIPONT
SP 0,25	0,85	0,9 (60W)	0,35		G10b, G11b, G50a, G50b, G12, G13, BI, BI P, DBI, DBI P, SEMIPONT, SEMITOP, SEMIPACK, SEMITRANS, SEMIX, MiniSkiiP
P 0,7	1,21	0,8 (100W)	0,21		B3 ... B7, E10 ... E17, E31, DO-8, E42 ... E46, G10b, G11b, G50a, G50b, G12, G13, B8, B10, B11, B11b, B14, B21, B23, E25, E26, E27, E35, SEMIPONT, SEMITOP, SEMIPACK, SEMITRANS, SEMIX, MiniSkiiP

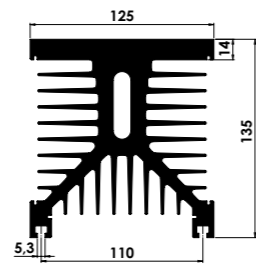
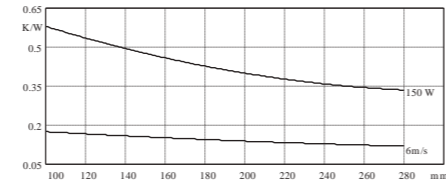
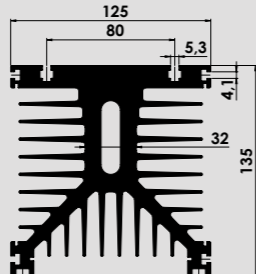
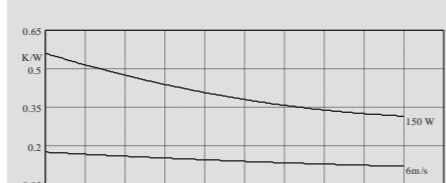
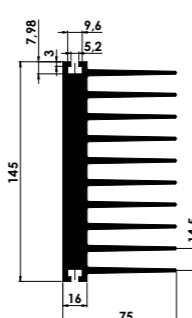
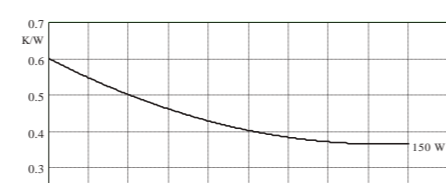
Heatsinks

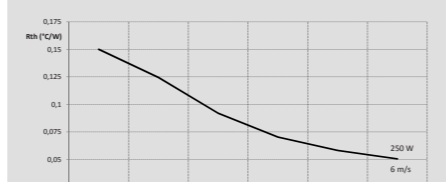
TYPES	WEIGHT kg/L=100mm	R_{thho}	R_{thho}	OUTLINES	THERMAL RESISTANCE
		NATURAL °C/W (L=200 mm)	FORCED °C/W (L=200 mm)		
P 03	1,82	0,38 (150 W)	0,11		B3 ... B7, E10 ... E17, E31, DO-8, E42 ... E46, G10b, G11b, G50a, G50b, G12, G13, SEMIPONT, SEMITOP, SEMIPACK, SEMITRANS, SEMIX, MiniSKiIP 
P 3	1,76	0,38 (150 W)	0,11		B3 ... B7, E10 ... E17, E31, DO-8, E42 ... E46, G10b, G11b, G50a, G50b, G12, G13, SEMIPONT, SEMITOP, SEMIPACK, SEMITRANS, SEMIX, MiniSKiIP 
P 0,71	1,05	0,43 (150 W)	---		B1 ... B3, E6 ... E12, E42, E43, G10b, G11b, G50a, G50b, G12, G13, BI, BI P, DBI, DBI P, SEMIPONT, SEMITOP, SEMIPACK, SEMITRANS, SEMIX, MiniSKiIP 
P 35	1,08	0,45 (250W)	0,15		G10b, G11b, G50a, G50b, G12, G13, BI, BI P, DBI, DBI P, SEMIPONT, SEMITOP, SEMIPACK, SEMITRANS, SEMIX, MiniSKiIP 

Heatsinks

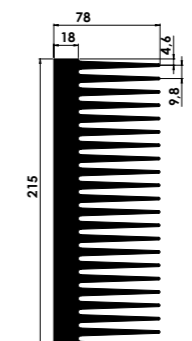
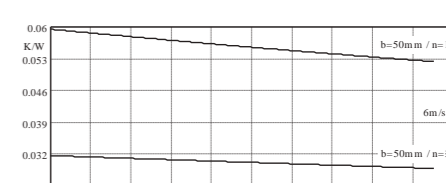
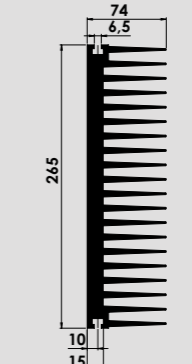
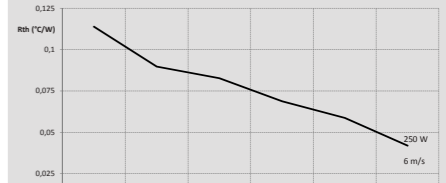
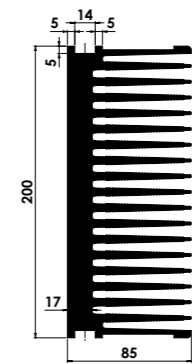
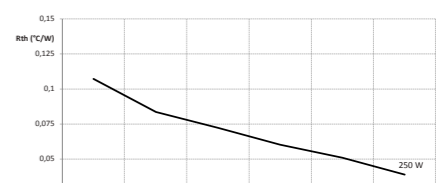
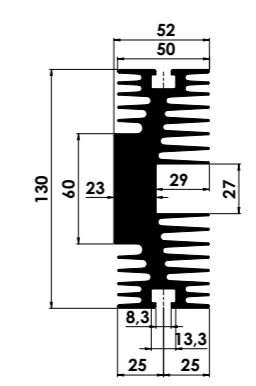
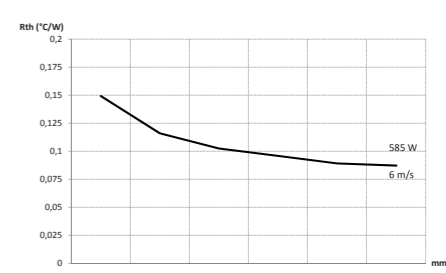
TYPES	WEIGHT kg/L=100mm	R_{thho}	R_{thho}	OUTLINES	THERMAL RESISTANCE
		NATURAL °C/W (L=200 mm)	FORCED °C/W (L=200 mm)		
P 16	2,35	0,4 ¹⁾	0,0381 ¹⁾		SEMIPONT, SEMITOP, SEMIPACK, SEMITRANS, SEMIX, MiniSKiIP, SKiM 
P 122	2,25	---	0,0823		SEMIPONT, SEMITOP, SEMIPACK, SEMITRANS, SEMIX, MiniSKiIP, SKiM 
PX17	2,36	---	0,0723		SEMIPONT, SEMITOP, SEMIPACK, SEMITRANS, SEMIX, MiniSKiIP, SKiM 
2x P 8,5	0,91	---	0,1025		B8, B10, B11, B11b, B14, B21, B23, E25, E26, E27, E35 

For more detailed information, contact SEMIKRON

1) With 3 SEMIPACK®1 modules

Heatsinks

TYPES	WEIGHT kg/L=100mm	R_{thho}	R_{thho}	OUTLINES	THERMAL RESISTANCE
		NATURAL °C/W (L=200 mm)	FORCED °C/W (L=200 mm)		
2 x P 9	1,7	0,23 (585W)	0,061		B8, B10, B11, B11b, B14, B21, B23, E25, E26, E27, E35
P 0,9 2 x P 0,9	0,745 1,49	0,7 0,33 (585W)	----- 0,777		B8, B10, B11, B11b, B12, B14, B21, B22, B23, B24
2 x P 0,45	2,5	0,22 (585W)	0,053		B8, B10, B11, B11b, B14, B21, B23, E25, E26, E27, E35
2 x P 0,53	1,7	0,19 (300W)	0,055		B8, B10, B11, B11b, B14, B21, B23, E25, E26, E27, E35

Clamps

CLAMP	HEATSINK	CLAMPING FORCE [kgf]	DIMENSIONS				WITH SEMICONDUCTOR
			a [mm]	b [mm]	c [mm]	d [mm]	
GV 70.010	P0,9	450	110	15	14	145	SKN 503 SG
GV 70.011	P0,53	450	130	19	14	155	SKT 340
GV 70.012	P0,7	450	140	24	14	160	
GV 70.020	P0,9	700	110	15	14	145	SKT 551
GV 70.021	P0,53	700	130	19	14	155	
GV 70.022	P0,7	700	140	24	14	160	SKT 553 SG
GV 70.030	P0,9	1200	110	15	14	145	SKN 1603
GV 70.031	P0,53	1200	130	19	14	155	SKT 813
GV 70.032	P0,7	1200	140	28	14	160	
GV 70.032	P0,45	1200	140	28	14	160	
GV 70.031	P0,53	1200	150	19	26	170	SKN 1503 SG
GV 70.032	P0,7	1200	150	28	26	185	SKT 760
GV 70.032	P0,45	1200	150	28	26	185	
GV 70.040	P0,9	1500	140	15	26	160	
GV 70.041	P0,53	1500	150	19	26	170	SKT 883
GV 70.042	P0,7	1500	150	28	26	185	
GV 70.042	P0,45	1500	150	28	26	185	
GV 100.012	P0,45	2400	150	28	26	177	SKT 1200
GV 100.022	P0,45	2700	130	28	8	177	SKN 6000

For more detailed information, contact SEMIKRON

Stacks

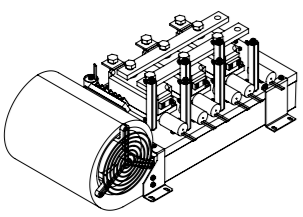
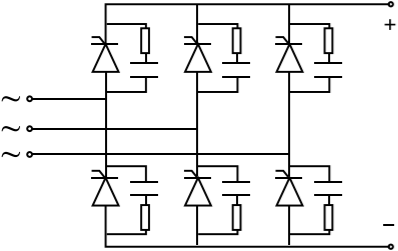
Ref. Number: 08646240	V_{AC} (IN)	V_{DC}	I_{AC} (OUT)	COOLING	HEATSINK	COMPONENT FAMILY
	V	V	A			
						
	330	445	600	Fan	P16	SEMIPACK

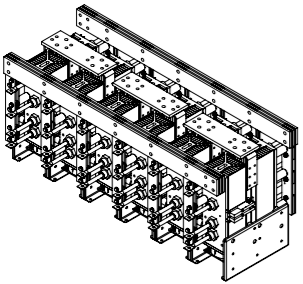
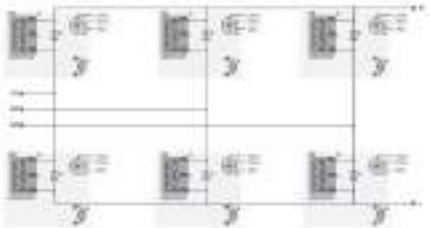
Ref. Number: 08636290	V_{AC} (IN)	V_{DC}	I_{AC} (OUT)	COOLING	HEATSINK	COMPONENT FAMILY
	V	V	A			
						
	120	160	6000	Fan	P.03	Stud Diode

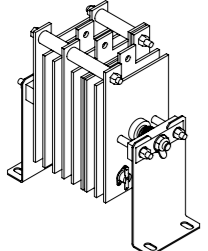
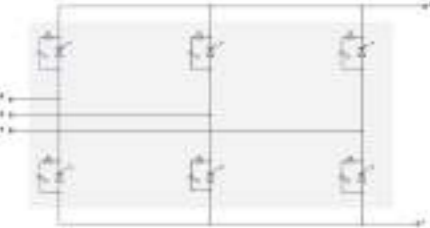
Ref. Number: 08646580	V_{AC} (IN)	V_{DC}	I_{AC} (OUT)	COOLING	HEATSINK	COMPONENT FAMILY
	V	V	A			
						
	70	100	460*	Natural	-----	Capsule Diode Capsule Thyristor

*With air cooling flow rate 4 m/s @60 s.

Stacks

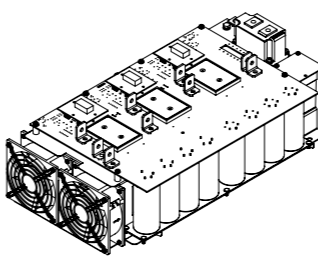
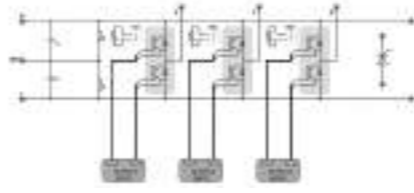
Ref. Number: 08646160	V_{AC} (IN)	V_{DC}	I_{AC} (OUT)	FREQUENCY	COOLING	HEATSINK	COMPONENT FAMILY
	V	V	A	Fsw kHz			
							
	220	400	97	7,7	Fan	P16	MiniSKiP

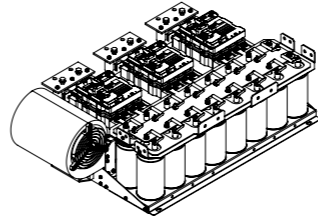
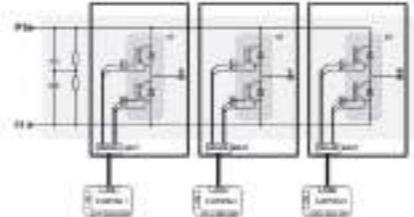
Ref. Number: 08646270	V_{AC} (IN)	V_{DC}	I_{AC} (OUT)	FREQUENCY	COOLING	HEATSINK	COMPONENT FAMILY
	V	V	A	Fsw kHz			
							
	380	710	305	4	Fan	-----	SKiP

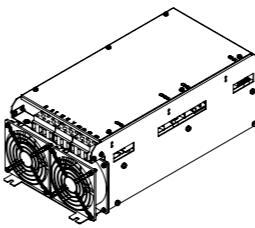
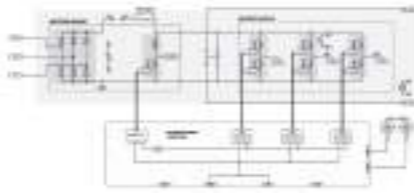
Ref. Number: 08645890	V_{AC} (IN)	V_{DC}	I_{AC} (OUT)	FREQUENCY	COOLING	HEATSINK	COMPONENT FAMILY
	V	V	A	Fsw kHz			
							
	480	680	36	8	Fan	P16	SEMiX

For more detailed information, contact SEMIKRON

Letter Symbols

V_{BRM}	Máx. tensão reversa repetitiva de pico	Máx. tensión reversa repetitiva permisible	Repetitive peak reverse voltage
V_{DRM}	Máx. tensão direta repetitiva de pico	Máx. tensión directa repetitiva permisible	Repetitive peak off-stage voltage
I_{TAV}	Corrente média máxima direta (Tiristores)	Corriente media máxima directa (Tiristores)	Mean on-state current (Thyristors)
I_{FAV}	Corrente média máxima direta (Diodos)	Corriente media máxima directa (Diodos)	Mean on-state current (Diodes)
I_{TRMS}	Valor eficaz da corrente (Tiristores)	Valor máx. eficaz de corriente (Tiristores)	RMS on-state current (Thyristors)
I_{FRMS}	Valor eficaz da corrente (Diodos)	Valor máx eficaz de corriente (Diodos)	RMS on-state current (Diodes)
I_{TSM}	Corrente de surto máxima não repetitiva para 10ms (Tiristores)	Valor de cresta máx. de la corriente no repetitiva para 10ms (Tiristores)	No repetitive surge on-state current for 10ms (Thyristors)
I_{FSM}	Corrente de surto máxima não repetitiva para 10ms (Diodos)	Valor de cresta máx. de la corriente no repetitiva para 10ms (Diodos)	No repetitive surge on-state current for 10ms (Diodes)
I^2T	Capacidade máxima de corrente não repetitiva no sentido direto para 10ms	Capacidad máx. de la corriente no repetitiva en el sentido directo para 10ms	I^2t value for 10ms
$\left(\frac{dV}{dT}\right)_{CR}$	Taxa de subida máxima da tensão com o tempo	Gradiente critico de la tensión	Rate of rise of off-state voltage
V_T	Queda de tensão no sentido direto em função da corrente I_T (Tiristores)	Caida de la tensión en el sentido directo en función de la corriente I_T (Tiristores)	On-state voltage in function of on-state current I_T (Thyristors)
V_F	Queda de tensão no sentido direto em função da corrente I_F (Diodos)	Caida de la tensión en el sentido directo en función de la corriente I_F (Diodos)	On-state voltage in function of on-state current I_F (Diodes)
I_T	Corrente direta (Tiristores)	Corriente directa (Tiristores)	On-state current (Thyristors)
I_F	Corrente direta (Diodos)	Corriente directa (Diodos)	On-state current (Diodes)
r_T	Resistência aparente no sentido direto	Resistencia aparente en el sentido directo	On-state slope resistance
I_H	Corrente de manutenção	Corriente de enganche	Holding current
I_L	Corrente de fixação	Corriente de fijación	Latching current
V_{GT}	Tensão de disparo	Tensión del gatillo	Gate trigger voltage
I_{GT}	Corrente de disparo	Corriente del gatillo	Gate trigger current
t_{rr}	Tempo de recuperação reversa	Tiempo de recuperación reversa	Reverse recovery time
T_{amb}	Temperatura ambiente	Temperatura ambiente	Ambient temperature
T_{vj}	Temperatura de junção	Temperatura de la unión	Virtual junction temperature
R_{thja}	Resistência térmica entre junção e meio-ambiente	Resistencia térmica unión-medio ambiente	Thermal resistance junction to ambient air
R_{thjF}	Resistência entre junção e terminal	Resistencia térmica unión-terminal	Thermal resistance junction to lead
R_{thjC}	Resistência térmica entre junção e encapsulamento	Resistencia térmica unión-encapsulamiento	Thermal resistance junction to case
R_{thcs}	Resistência térmica entre encapsulamento e dissipador	Resistencia térmica encapsulamiento-dissipador	Thermal resistance case to heatsink
R_{thca}	Resistência térmica entre encapsulamento e meio-ambiente	Resistencia térmica encapsulamiento-medio ambiente	Thermal resistance case to ambient air
R_{thsa}	Resistência térmica entre dissipador e meio-ambiente	Resistencia térmica dissipador-medio ambiente	Thermal resistance heatsink to ambient air
$V_{T(RO)}$	Tensão de limiar (Tiristores)	Tensión de umbral (Tiristores)	Threshold voltage (Thyristors)
$V_{T(DO)}$	Tensão de limiar (Diodos)	Tensión de umbral (Diodos)	Threshold voltage (Diodes)
f	Frequência de trabalho	Frecuencia de trabajo	Working frequency
I_D	Corrente de saída do conversor	Corriente de salida del convertidor	Converter output current
V_D	Tensão de saída do conversor	Tensión de salida del convertidor	Converter output voltage
I_i	Corrente de entrada no conversor	Corriente de entrada en el convertidor	Converter input current
V_i	Tensão de entrada no conversor	Tensión de entrada en el convertidor	Converter input voltage
$\left(\frac{dI}{dT}\right)_{CR}$	Taxa máxima de subida da corrente com o tempo	Gradiente critico de la corriente	Critical rate of rise of on-state current
T_C	Temperatura do encapsulamento	Temperatura de lo encapsulamiento	Case temperature

Letter Symbols

T_{ref}	Temperatura do terminal	Temperatura del terminal	Lead temperature
$V_{(BR)}$	Tensão de avalanche	Tensión de avalanche	Breakdown voltage
I_{TM}	Corrente direta de pico	Corriente directa de crista	Peak on-state current
$I_{nom\ recom.}$	Corrente nominal recomendada	Corriente nominal recomendada	Recommended nominal current
Vel. Ar	Velocidade do ar	Velocidad del aire	Air velocity
P_{tot}	Potência total dissipada	Potencia disipada total	Total power dissipation
P_D	Potência dissipada	Potencia disipada	Power dissipation
T_j	Temperatura da junção	Temperatura de la unión	Junction temperature
M_1	Torque para montagem do módulo no dissipador	Torque para montaje del módulo en el dissipador	Mounting torque module to heatsink
M_2	Torque de aperto para conexões	Torque para apretar las conexiones	Mounting torque bus bars to module
M_s	Torque de montagem do componente rosca	Torque de montaje del componente rosca	Mounting torque for the stud device
$M_{S\ Grease}$	Torque de montagem do componente rosca com pasta térmica	Torque de montaje del componente rosca con pasta térmica	Mounting torque for the stud device with thermal grease
F	Força de montagem do componente disco	Fuerza de montaje del componente disco	Mounting force for the capsule device



shop.semikron.com.br



youtube.com.br/c/semikron



linkedin.com/company/semikron

SEMIKRON Semicondutores Ltda.

Av. Inocência Seráfico, 6300
Carapicuíba - São Paulo, Brasil
06366-900
Tel: +55 11 4186.9500
skbr-sales@semikron.com

www.semikron.com
shop.semikron.com.br

